

Uni-ka 594

UNI-KA COLLECTION:

Uni-ka 594, Uni-Ka 594M, Uni-Ka 595, Uni-Ka 595M, Uni-Ka 596, Uni-Ka 596M, Uni-Ka 597-DP, Uni-Ka 597-DR, Uni-Ka 597M-DP, Uni-Ka 597M-DR, Uni-Ka 598, Uni-Ka 598M, Uni-Ka 599M, Uni-Ka 599, Uni-Ka 600, Uni-Ka 600M, Uni-Ka 601, Uni-Ka 601M, Uni-Ka 604, Uni-Ka 604M,

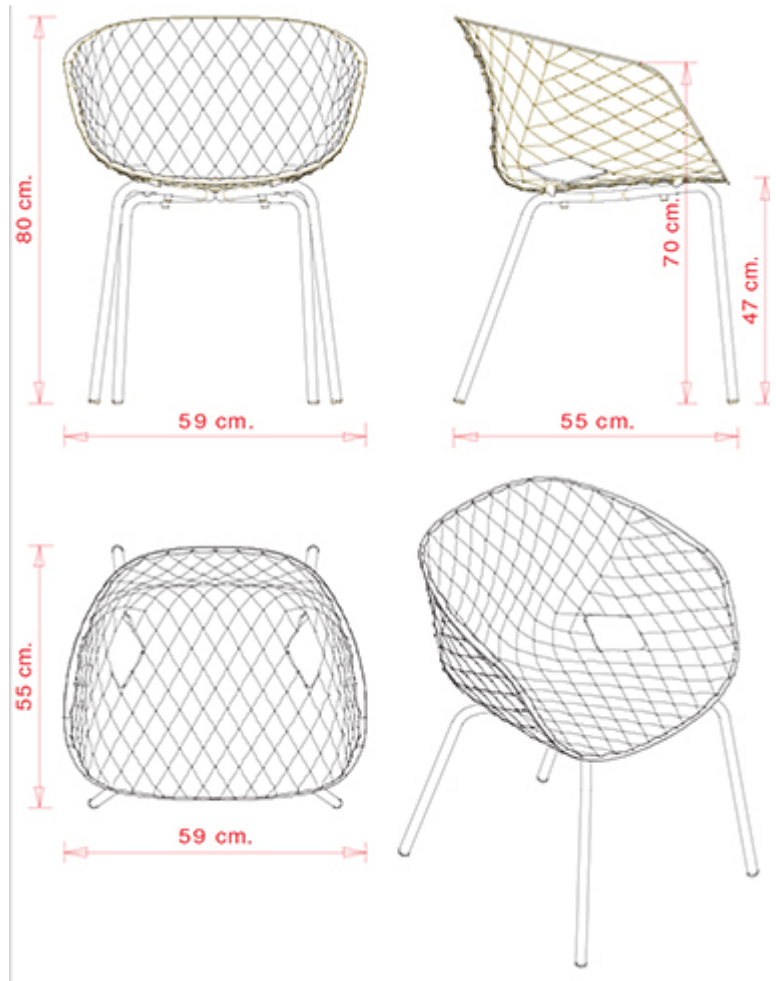

Armchair with stell frame, 4 legs. Polypropylene shell.

STACKABLE

4

WEIGHT

6,4 kg

PACK

0,42 m³

PIECES PER BOX

4

FINISHES SEATING

PP POLYPROPYLENE



RAL 9016 Traffic white
≡



RAL 3000 Flame red
≡



RAL 7016 Anthracite grey
≡



RAL 2003 Pastel orange
≡

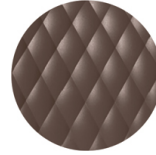

NCS S7005-Y50R
Cocoa
≡



RAL 9005 Jet black
≡



PANTONE 380 C
Boss green
≡



NCS S4005-Y50R Turtle-dove
≡



PANTONE 18-1438
Marsala
≡

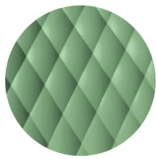

RAL 6021 Pale green
≡

FRAMES

AC STEEL

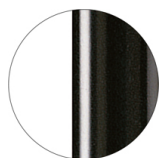

RAL 9005
VR Jet black

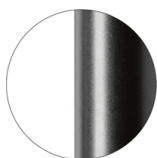

RAL 9005
VR Matt Jet Black



RAL 9016
VR Traffic white



RAL 9010
VR Pure white

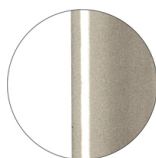

PANTONE 402 C
VR Turtle-dove

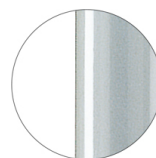

RAL 9006
VR White aluminium

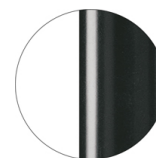

RAL 7016
VR Anthracite grey

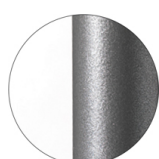

VR Pewter

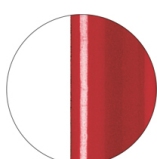

RAL 3003
VR Ruby red



RAL 8017
VR Chocolate brown



RAL 6005
VR Moss green

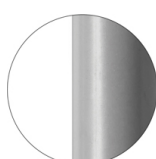

RAL 7037
VR Matt Dusty grey

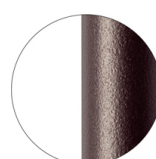

VR Rough metallic
bronze

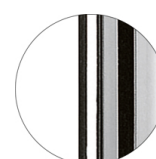

CR Chrome

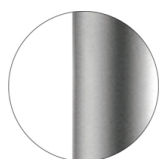

CR S Satin chrome



CR X Brass chrome

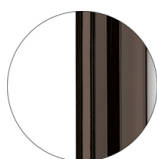

CR X Burnished chrome

CERTIFICATIONS

- > ANSI/BIFMA X5.1-2011 - Par.11. Prove di fatica sulla seduta (24/01/14)
- > ANSI/BIFMA X5.1-2011 - Par.13. Sforzo statico verticale sui braccioli (27/05/14)
- > ANSI/BIFMA X5.1-2011 - Par.14. Sforzo statico orizzontale sui braccioli (27/05/14)
- > ANSI/BIFMA X5.1-2011 - Par.16. Prove di fatica sullo schienale (24/01/14)
- > ANSI/BIFMA X5.1-2011 - Par.21. Prova di fatica sui braccioli (27/05/14)
- > ANSI/BIFMA X5.1-2011 - Par.6. Sforzo statico sullo schienale (24/01/14)
- > ANSI/BIFMA X5.1-2011 - Par.8. Caduta di un peso (24/01/14)
- > UNI/EN 16139:2013 - Par.4.1. Generale. 4.2 Cesoiamento (19/03/14)
- > UNI/EN 16139:2013 - Par.4.3. Stabilità (19/03/14) > UNI/EN 16139:2013 - Par.7. Informazioni per l'uso (19/03/14)
- > UNI/EN 16139:2013 - Prova 1. Carico statico sedile e schienale: 2-Uso estremo (19/03/14)
- > UNI/EN 16139:2013 - Prova 10. Prova di fatica dei braccioli: 2-Uso estremo (19/03/14)
- > UNI/EN 16139:2013 - Prova 12. Carico statico gambe anteriori: 2-Uso estremo (19/03/14)
- > UNI/EN 16139:2013 - Prova 13. Carico statico gambe laterali: 2-Uso estremo (19/03/14)
- > UNI/EN 16139:2013 - Prova 14. Prova di urto sul sedile: 2-Uso estremo (19/03/14)
- > UNI/EN 16139:2013 - Prova 15. Prova di urto sullo schienale: 2-Uso estremo (19/03/14)
- > UNI/EN 16139:2013 - Prova 16. Prova di urto sul bracciolo: 2-Uso estremo (19/03/14)
- > UNI/EN 16139:2013 - Prova 2. Carico statico sul fronte anteriore: 2-Uso estremo (19/03/14)
- > UNI/EN 16139:2013 - Prova 3. Carico verticale sullo schienale: 2-Uso estremo (19/03/14)
- > UNI/EN 16139:2013 - Prova 5. Carico statico laterale sui braccioli: 2-Uso estremo (19/03/14)
- > UNI/EN 16139:2013 - Prova 6. Carico statico verticale verso il basso sui braccioli: 2-Uso estremo (19/03/14)
- > UNI/EN 16139:2013 - Prova 7. Carico statico verticale verso l'alto sui braccioli: 2-Uso estremo (19/03/14)
- > UNI/EN 16139:2013 - Prova 8. Prova di fatica sedile e schienale: 2-Uso estremo (19/03/14)
- > UNI/EN 16139:2013 - Prova 9. Prova di fatica sul bordo anteriore: 2-Uso estremo (19/03/14)

Uni-Ka 594M

UNI-KA COLLECTION:

Uni-ka 594, Uni-Ka 594M, Uni-Ka 595, Uni-Ka 595M, Uni-Ka 596, Uni-Ka 596M, Uni-Ka 597-DP, Uni-Ka 597-DR, Uni-Ka 597M-DP, Uni-Ka 597M-DR, Uni-Ka 598, Uni-Ka 598M, Uni-Ka 599M, Uni-Ka 599, Uni-Ka 600, Uni-Ka 600M, Uni-Ka 601, Uni-Ka 601M, Uni-Ka 604, Uni-Ka 604M,

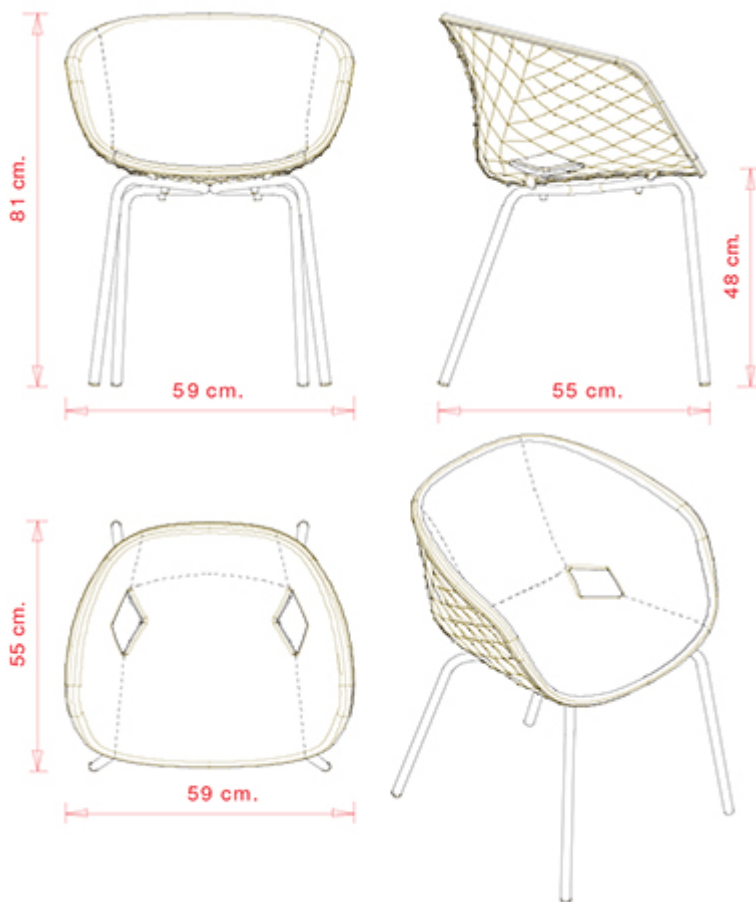

Armchair with stell frame, 4 legs. Upholstered polypropylene shell.

WEIGHT

9,3 Kg

PACK

0,34 m³

PIECES PER BOX

1

FINISHES SEATING

TE FABRICS



Citadel Camira
+ 16 colours



Inca Abitex
+ 15 colours



Medley Gabriel
+ 14 colours

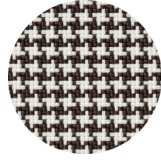

Go-Couture Gabriel
+ 8 colours



Crazy Flukso
+ 7 colours



Xtreme Camira
+ 16 colours

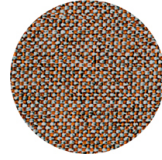

Rivet Camira
+ 12 colours

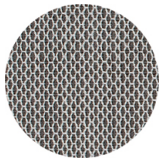

Criss Cross Gabriel
+ 19 colours



Valencia Spradling
+ 17 colours

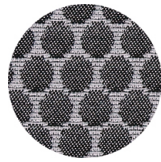

Bubble Flukso
+ 9 colours



Europost 2 Gabriel
+ 16 colours



Fame Gabriel
+ 23 colours



Parotega NF
Skai Hornschuch
+ 8 colours

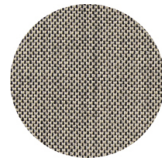

Balta Vescom
+ 12 colours

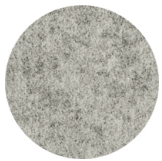

Blazer Camira
+ 14 colours

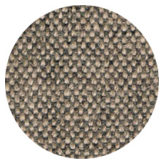

Main line flax Camira
+ 13 colours

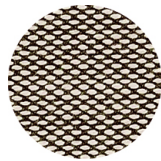

Steelcut trio 3
Kvadrat
+ 20 colours

PP POLYPROPYLENE



RAL 9016 Traffic white
≡



RAL 3000 Flame red
≡



RAL 7016 Anthracite
grey
≡



RAL 2003 Pastel
orange
≡

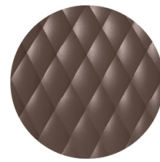

NCS S7005-Y50R
Cocoa
≡



RAL 9005 Jet black
≡



PANTONE 380 C
Boss green
≡



NCS S4005-Y50R Turtle-
dove
≡



PANTONE 18-1438
Marsala
≡

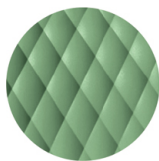

RAL 6021 Pale green
≡

FRAMES

AC STEEL

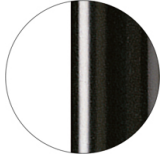

RAL 9005
VR Jet black
☀

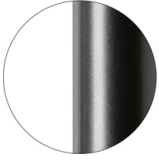

RAL 9005
VR Matt Jet Black
☀



RAL 9016
VR Traffic white
☀



RAL 9010
VR Pure white
☀

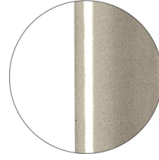

PANTONE 402 C
VR Turtle-dove
☀

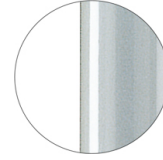

RAL 9006
VR White aluminium
☀

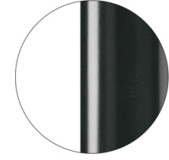

RAL 7016
VR Anthracite grey
☀

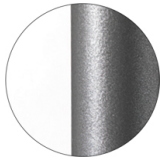

VR Pewter
☀

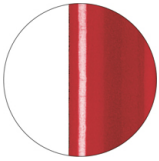

RAL 3003
VR Ruby red
☀



RAL 8017
VR Chocolate brown
☀



RAL 6005
VR Moss green
☀

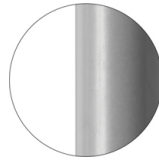

RAL 7037
VR Matt Dusty grey
☀

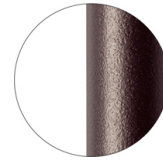

VR Rough metallic
bronze
☀



CR Chrome

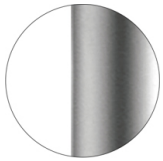

CR S Satin chrome



CR X Brass chrome

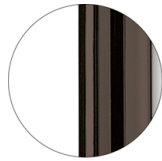

CR X Burnished chrome

Uni-Ka 595

UNI-KA COLLECTION:

Uni-ka 594, Uni-Ka 594M, Uni-Ka 595, Uni-Ka 595M, Uni-Ka 596, Uni-Ka 596M, Uni-Ka 597-DP, Uni-Ka 597-DR, Uni-Ka 597M-DP, Uni-Ka 597M-DR, Uni-Ka 598, Uni-Ka 598M, Uni-Ka 599M, Uni-Ka 599, Uni-Ka 600, Uni-Ka 600M, Uni-Ka 601, Uni-Ka 601M, Uni-Ka 604, Uni-Ka 604M,

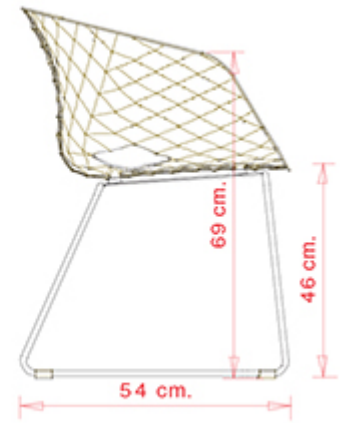

Armchair with sled steel frame and polypropylene shell.

WEIGHT

7,6 kg

PACK

0,34 m³

PIECES PER BOX

1

FINISHES SEATING

PP POLYPROPYLENE



RAL 9016 Traffic white
≡



RAL 3000 Flame red
≡



RAL 7016 Anthracite grey
≡



RAL 2003 Pastel orange
≡

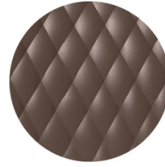

NCS S7005-Y50R
Cocoa
≡



RAL 9005 Jet black
≡



PANTONE 380 C
Boss green
≡



NCS S4005-Y50R
Turtle-dove
≡



PANTONE 18-1438
Marsala
≡

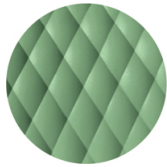

RAL 6021 Pale green
≡

FRAMES

AC STEEL

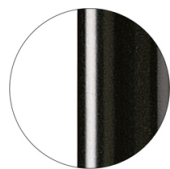

RAL 9005
VR Jet black

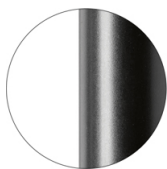

RAL 9005
VR Matt Jet Black



RAL 9016
VR Traffic white



RAL 9010
VR Pure white

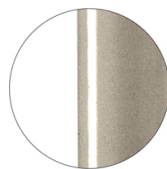

PANTONE 402 C
VR Turtle-dove

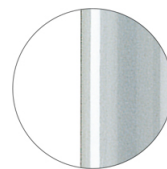

RAL 9006
VR White aluminium

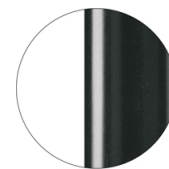

RAL 7016
VR Anthracite grey

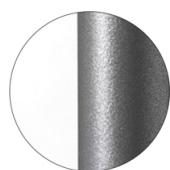

VR Pewter

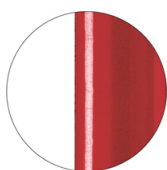

RAL 3003
VR Ruby red

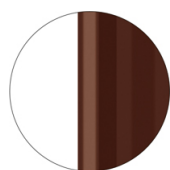

RAL 8017
VR Chocolate brown

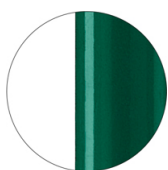

RAL 6005
VR Moss green

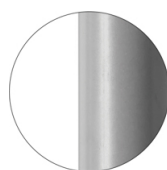

RAL 7037
VR Matt Dusty grey

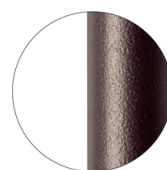

VR Rough metallic
bronze

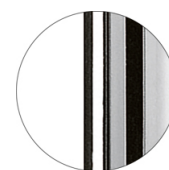

CR Chrome

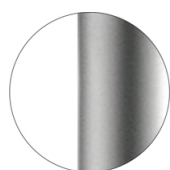

CR S Satin chrome

CERTIFICATIONS

> UNI/EN 16139:2013 - Par.6. Prova 8. Prova di fatica sedile e schienale: 2-Usò estremo (20/06/16)

Uni-Ka 595M

UNI-KA COLLECTION:

Uni-ka 594, Uni-Ka 594M, Uni-Ka 595, Uni-Ka 595M, Uni-Ka 596, Uni-Ka 596M, Uni-Ka 597-DP, Uni-Ka 597-DR, Uni-Ka 597M-DP, Uni-Ka 597M-DR, Uni-Ka 598, Uni-Ka 598M, Uni-Ka 599M, Uni-Ka 599, Uni-Ka 600, Uni-Ka 600M, Uni-Ka 601, Uni-Ka 601M, Uni-Ka 604, Uni-Ka 604M,

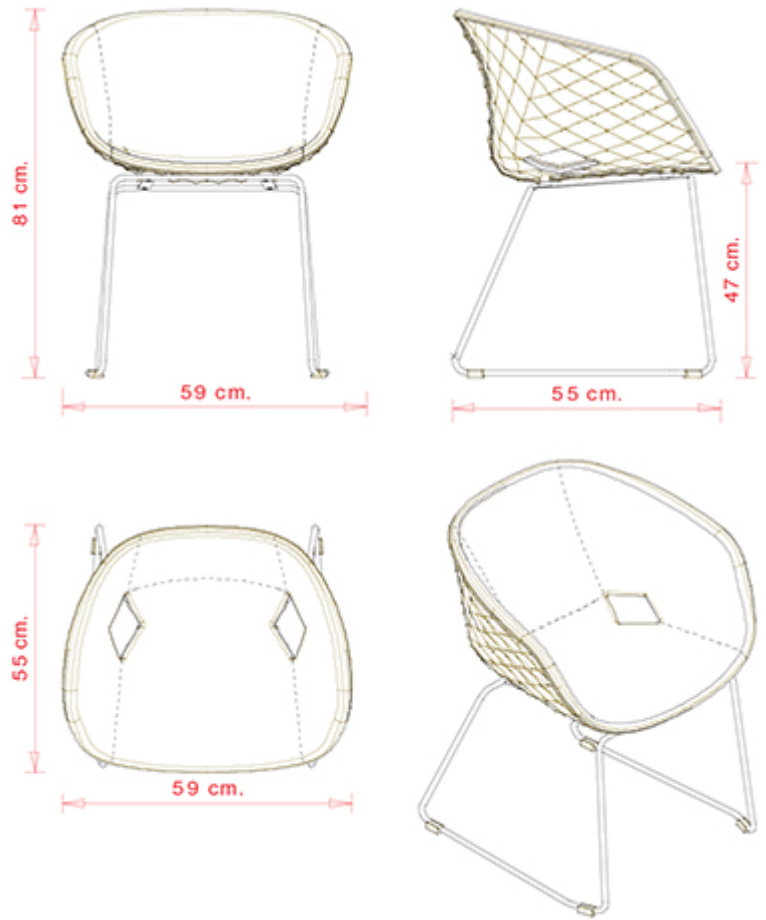

Armchair with sled steel frame. Upholstered polypropylene shell.

WEIGHT

10,5 Kg

PACK

0,34 m³

PIECES PER BOX

1

FINISHES SEATING

TE FABRICS



Citadel Camira
+ 16 colours



Inca Abitex
+ 15 colours



Medley Gabriel
+ 14 colours

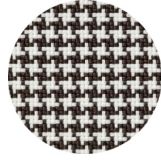

Go-Couture Gabriel
+ 8 colours



Crazy Flukso
+ 7 colours



Xtreme Camira
+ 16 colours

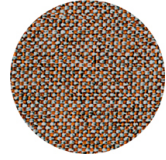

Rivet Camira
+ 12 colours

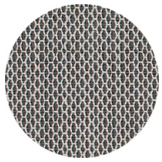

Criss Cross Gabriel
+ 19 colours



Valencia Spradling
+ 17 colours



Bubble Flukso
+ 9 colours



Europost 2 Gabriel
+ 16 colours



Fame Gabriel
+ 23 colours



Parotega NF
Skai Hornschuch
+ 8 colours

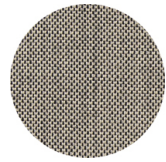

Balta Vescom
+ 12 colours

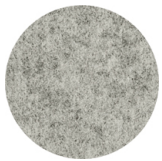

Blazer Camira
+ 14 colours

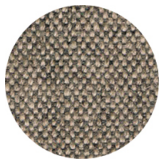

Main line flax Camira
+ 13 colours

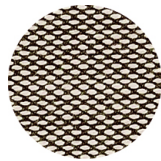

Steelcut trio 3
Kvadrat
+ 20 colours

PP POLYPROPYLENE



RAL 9016 Traffic white
≡



RAL 3000 Flame red
≡



RAL 7016 Anthracite
grey
≡



RAL 2003 Pastel
orange
≡



NCS S7005-Y50R
Cocoa
≡



RAL 9005 Jet black
≡



PANTONE 380 C
Boss green
≡



NCS S4005-Y50R Turtle-
dove
≡



PANTONE 18-1438
Marsala
≡

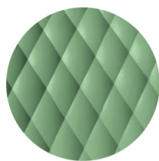

RAL 6021 Pale green
≡

FRAMES

AC STEEL

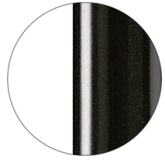

RAL 9005
VR Jet black
☀

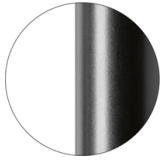

RAL 9005
VR Matt Jet Black
☀



RAL 9016
VR Traffic white
☀

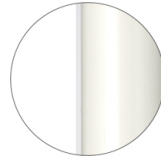

RAL 9010
VR Pure white
☀

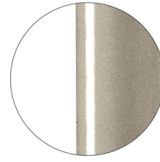

PANTONE 402 C
VR Turtle-dove
☀

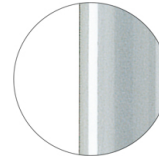

RAL 9006
VR White aluminium
☀

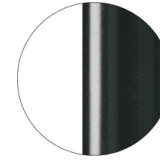

RAL 7016
VR Anthracite grey
☀

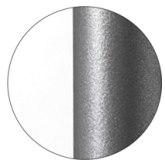

VR Pewter
☀

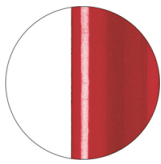

RAL 3003
VR Ruby red
☀

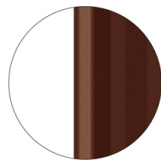

RAL 8017
VR Chocolate brown
☀



RAL 6005
VR Moss green
☀

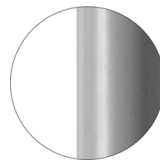

RAL 7037
VR Matt Dusty grey
☀

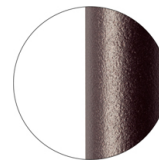

VR Rough metallic
bronze
☀



CR Chrome

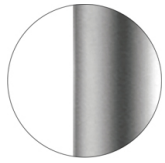

CR S Satin chrome

Uni-Ka 596

UNI-KA COLLECTION:

Uni-ka 594, Uni-Ka 594M, Uni-Ka 595, Uni-Ka 595M, Uni-Ka 596, Uni-Ka 596M, Uni-Ka 597-DP, Uni-Ka 597-DR, Uni-Ka 597M-DP, Uni-Ka 597M-DR, Uni-Ka 598, Uni-Ka 598M, Uni-Ka 599M, Uni-Ka 599, Uni-Ka 600, Uni-Ka 600M, Uni-Ka 601, Uni-Ka 601M, Uni-Ka 604, Uni-Ka 604M,



Armchair with wire steel frame. Polypropylene shell.

WEIGHT

6,9 kg

PACK

0,34 m³

PIECES PER BOX

1

FINISHES SEATING

PP POLYPROPYLENE



RAL 9016 Traffic white
≡



RAL 3000 Flame red
≡



RAL 7016 Anthracite grey
≡



RAL 2003 Pastel orange
≡



NCS S7005-Y50R
Cocoa
≡



RAL 9005 Jet black
≡



PANTONE 380 C
Boss green
≡



NCS S4005-Y50R
Turtle-dove
≡



PANTONE 18-1438
Marsala
≡

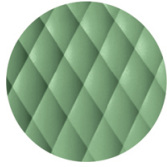

RAL 6021 Pale green
≡

FRAMES

AC STEEL

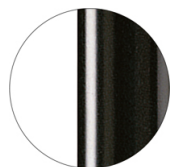

RAL 9005
VR Jet black

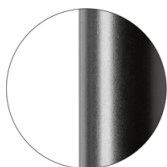

RAL 9005
VR Matt Jet Black



RAL 9016
VR Traffic white



RAL 9010
VR Pure white

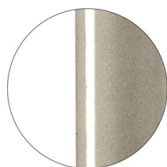

PANTONE 402 C
VR Turtle-dove

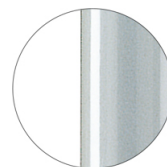

RAL 9006
VR White aluminium

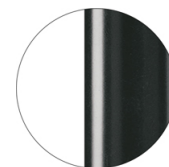

RAL 7016
VR Anthracite grey

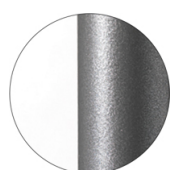

VR Pewter

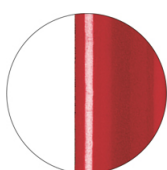

RAL 3003
VR Ruby red



RAL 8017
VR Chocolate brown

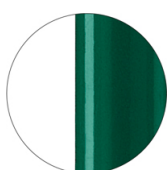

RAL 6005
VR Moss green

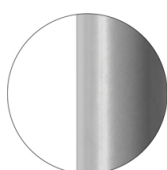

RAL 7037
VR Matt Dusty grey

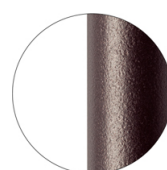

VR Rough metallic
bronze



CR Chrome

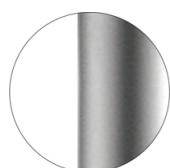

CR S Satin chrome

CERTIFICATIONS

> UNI/EN 16139:2013 - Par.6. Prova 8. Prova di fatica sedile e schienale: 2-Usò estremo (11/11/16)

Uni-Ka 596M

UNI-KA COLLECTION:

Uni-ka 594, Uni-Ka 594M, Uni-Ka 595, Uni-Ka 595M, Uni-Ka 596, Uni-Ka 596M, Uni-Ka 597-DP, Uni-Ka 597-DR, Uni-Ka 597M-DP, Uni-Ka 597M-DR, Uni-Ka 598, Uni-Ka 598M, Uni-Ka 599M, Uni-Ka 599, Uni-Ka 600, Uni-Ka 600M, Uni-Ka 601, Uni-Ka 601M, Uni-Ka 604, Uni-Ka 604M,

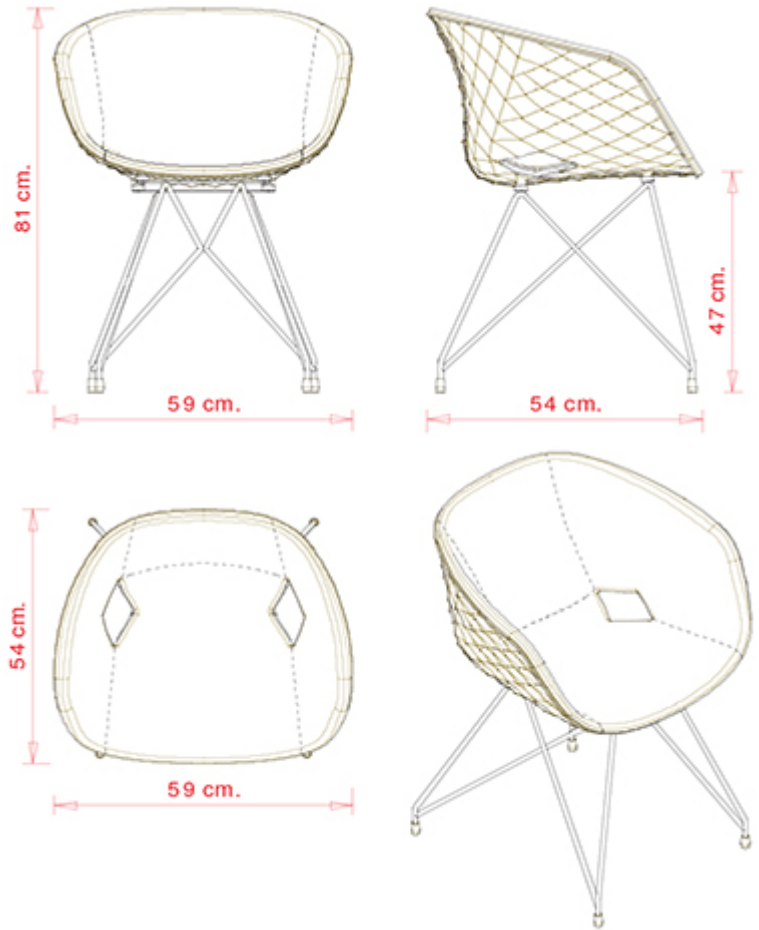

Armchair with wire steel frame. Upholstered polypropylene shell.

WEIGHT

9,8 Kg

PACK

0,34 m³

PIECES PER BOX

1

FINISHES SEATING

TE FABRICS



Citadel Camira
+ 16 colours



Inca Abitex
+ 15 colours



Medley Gabriel
+ 14 colours

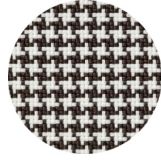

Go-Couture Gabriel
+ 8 colours



Crazy Flukso
+ 7 colours



Xtreme Camira
+ 16 colours

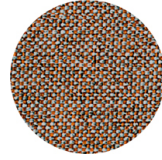

Rivet Camira
+ 12 colours

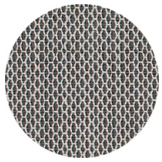

Criss Cross Gabriel
+ 19 colours



Valencia Spradling
+ 17 colours



Bubble Flukso
+ 9 colours



Europost 2 Gabriel
+ 16 colours



Fame Gabriel
+ 23 colours



Parotega NF
Skai Hornschuch
+ 8 colours

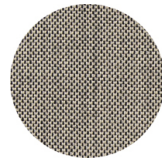

Balta Vescom
+ 12 colours

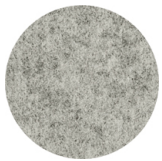

Blazer Camira
+ 14 colours

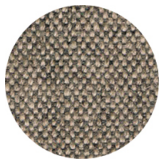

Main line flax Camira
+ 13 colours

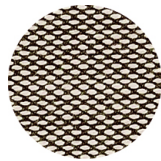

Steelcut trio 3
Kvadrat
+ 20 colours

PP POLYPROPYLENE



RAL 9016 Traffic white
≡



RAL 3000 Flame red
≡



RAL 7016 Anthracite
grey
≡



RAL 2003 Pastel
orange
≡



NCS S7005-Y50R
Cocoa
≡



RAL 9005 Jet black
≡



PANTONE 380 C
Boss green
≡



NCS S4005-Y50R Turtle-
dove
≡



PANTONE 18-1438
Marsala
≡

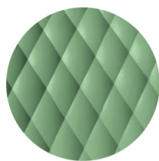

RAL 6021 Pale green
≡

FRAMES

AC STEEL

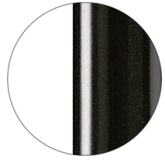

RAL 9005
VR Jet black
☀️

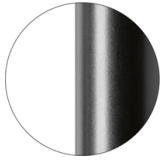

RAL 9005
VR Matt Jet Black
☀️



RAL 9016
VR Traffic white
☀️

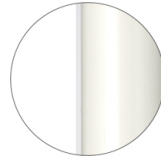

RAL 9010
VR Pure white
☀️

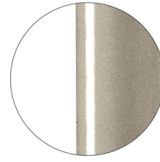

PANTONE 402 C
VR Turtle-dove
☀️

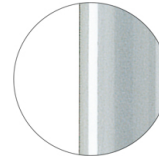

RAL 9006
VR White aluminium
☀️

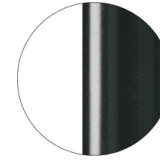

RAL 7016
VR Anthracite grey
☀️

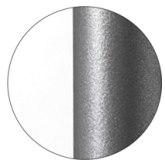

VR Pewter
☀️

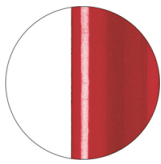

RAL 3003
VR Ruby red
☀️

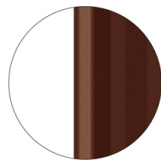

RAL 8017
VR Chocolate brown
☀️



RAL 6005
VR Moss green
☀️

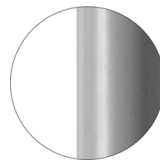

RAL 7037
VR Matt Dusty grey
☀️

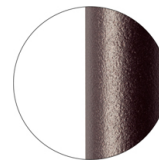

VR Rough metallic
bronze
☀️



CR Chrome

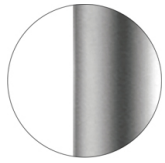

CR S Satin chrome

Uni-Ka 597-DP



UNI-KA COLLECTION:

Uni-ka 594, Uni-Ka 594M, Uni-Ka 595, Uni-Ka 595M, Uni-Ka 596, Uni-Ka 596M, Uni-Ka 597-DP, Uni-Ka 597-DR, Uni-Ka 597M-DP, Uni-Ka 597M-DR, Uni-Ka 598, Uni-Ka 598M, Uni-Ka 599M, Uni-Ka 599, Uni-Ka 600, Uni-Ka 600M, Uni-Ka 601, Uni-Ka 601M, Uni-Ka 604, Uni-Ka 604M,



Swivel armchair with 5 ways aluminium frame. Polypropylene shell.

WEIGHT

7,2 kg

PACK0,50 m³**PIECES PER BOX**

1

FINISHES SEATING

PP POLYPROPYLENE



RAL 9016 Traffic white
≡



RAL 3000 Flame red
≡



RAL 7016 Anthracite grey
≡



RAL 2003 Pastel orange
≡



NCS S7005-Y50R Cocoa
≡



RAL 9005 Jet black
≡



PANTONE 380 C Boss green
≡



NCS S4005-Y50R Turtle-dove
≡



PANTONE 18-1438 Marsala
≡

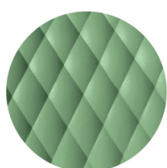

RAL 6021 Pale green
≡

FRAMES

AL PSH POLISHED ALUMINIUM



Polished aluminium

AL VR PAINTED ALUMINIUM

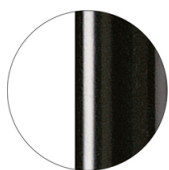

RAL 9005 VR Jet black
≡

Uni-Ka 597-DR



UNI-KA COLLECTION:

Uni-ka 594, Uni-Ka 594M, Uni-Ka 595, Uni-Ka 595M, Uni-Ka 596, Uni-Ka 596M, Uni-Ka 597-DP, Uni-Ka 597-DR, Uni-Ka 597M-DP, Uni-Ka 597M-DR, Uni-Ka 598, Uni-Ka 598M, Uni-Ka 599M, Uni-Ka 599, Uni-Ka 600, Uni-Ka 600M, Uni-Ka 601, Uni-Ka 601M, Uni-Ka 604, Uni-Ka 604M,



Swivel armchair with 5 ways on castors, aluminium frame. Polypropylene shell.

WEIGHT

7,2 kg

PACK0,50 m³**PIECES PER BOX**

1

FINISHES SEATING

PP POLYPROPYLENE



RAL 9016 Traffic white
≡



RAL 3000 Flame red
≡



RAL 7016 Anthracite grey
≡



RAL 2003 Pastel orange
≡

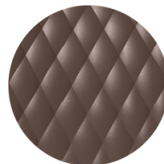

NCS S7005-Y50R
Cocoa
≡



RAL 9005 Jet black
≡



PANTONE 380 C
Boss green
≡

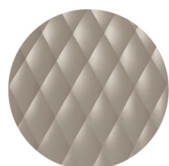

NCS S4005-Y50R
Turtle-dove
≡



PANTONE 18-1438
Marsala
≡

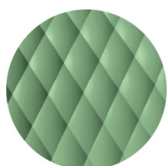

RAL 6021 Pale green
≡

FRAMES

AL PSH POLISHED ALUMINIUM



Polished aluminium

AL VR PAINTED ALUMINIUM

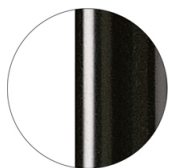

RAL 9005
VR Jet black
≡

Uni-Ka 597M-DP

UNI-KA COLLECTION:

Uni-ka 594, Uni-Ka 594M, Uni-Ka 595, Uni-Ka 595M, Uni-Ka 596, Uni-Ka 596M, Uni-Ka 597-DP, Uni-Ka 597-DR, Uni-Ka 597M-DP, Uni-Ka 597M-DR, Uni-Ka 598, Uni-Ka 598M, Uni-Ka 599M, Uni-Ka 599, Uni-Ka 600, Uni-Ka 600M, Uni-Ka 601, Uni-Ka 601M, Uni-Ka 604, Uni-Ka 604M,

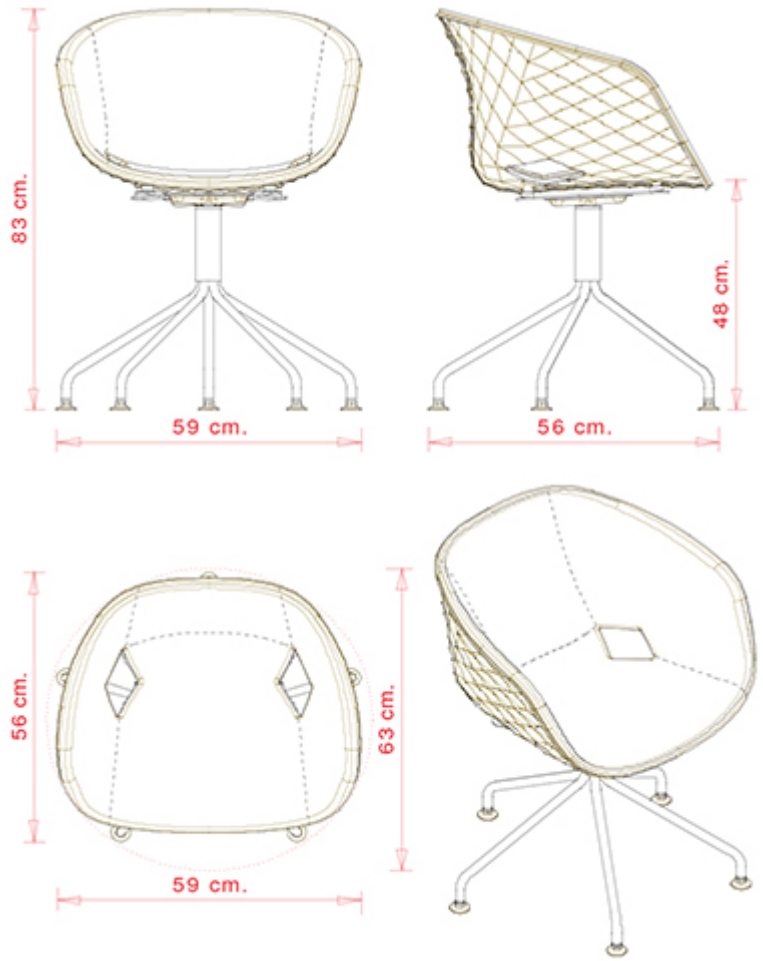

Swivel armchair with 5 ways aluminium frame. Upholstered polypropylene shell.

WEIGHT

9,5 Kg

PACK

0,50 m³

PIECES PER BOX

1

FINISHES SEATING

TE FABRICS



Citadel Camira
+ 16 colours



Inca Abitex
+ 15 colours



Medley Gabriel
+ 14 colours

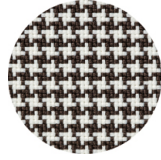

Go-Couture Gabriel
+ 8 colours



Crazy Flukso
+ 7 colours



Xtreme Camira
+ 16 colours

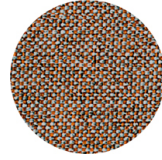

Rivet Camira
+ 12 colours

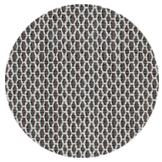

Criss Cross Gabriel
+ 19 colours



Valencia Spradling
+ 17 colours

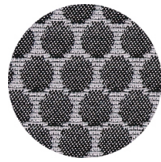

Bubble Flukso
+ 9 colours



Europost 2 Gabriel
+ 16 colours



Fame Gabriel
+ 23 colours



Parotega NF
Skai Hornschuch
+ 8 colours

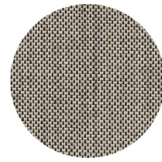

Balta Vescom
+ 12 colours

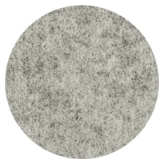

Blazer Camira
+ 14 colours

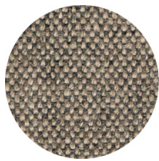

Main line flax Camira
+ 13 colours

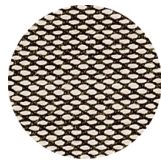

Steelcut trio 3
Kvadrat
+ 20 colours

PP POLYPROPYLENE



RAL 9016 Traffic white
≡



RAL 3000 Flame red
≡



RAL 7016 Anthracite
grey
≡



RAL 2003 Pastel
orange
≡

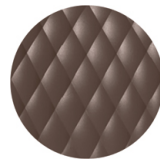

NCS S7005-Y50R
Cocoa
≡



RAL 9005 Jet black
≡



PANTONE 380 C
Boss green
≡



NCS S4005-Y50R Turtle-
dove
≡



PANTONE 18-1438
Marsala
≡

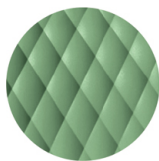

RAL 6021 Pale green
≡

FRAMES

AL PSH POLISHED ALUMINIUM



Polished aluminium

AL VR PAINTED ALUMINIUM

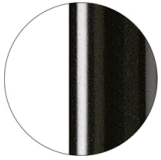

RAL 9005
VR Jet black



Uni-Ka 597M-DR



UNI-KA COLLECTION:

Uni-ka 594, Uni-Ka 594M, Uni-Ka 595, Uni-Ka 595M, Uni-Ka 596, Uni-Ka 596M, Uni-Ka 597-DP, Uni-Ka 597-DR, Uni-Ka 597M-DP, Uni-Ka 597M-DR, Uni-Ka 598, Uni-Ka 598M, Uni-Ka 599M, Uni-Ka 599, Uni-Ka 600, Uni-Ka 600M, Uni-Ka 601, Uni-Ka 601M, Uni-Ka 604, Uni-Ka 604M,



Swivel armchair with 5 ways on castors, aluminium frame. Upholstered polypropylene shell.

WEIGHT

9,5 Kg

PACK0,50m³**PIECES PER BOX**

1

FINISHES SEATING

TE FABRICS



Citadel Camira
+ 16 colours



Inca Abitex
+ 15 colours



Medley Gabriel
+ 14 colours

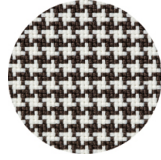

Go-Couture Gabriel
+ 8 colours



Crazy Flukso
+ 7 colours



Xtreme Camira
+ 16 colours

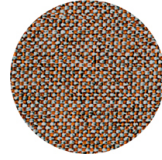

Rivet Camira
+ 12 colours

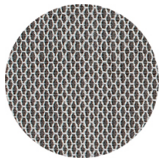

Criss Cross Gabriel
+ 19 colours



Valencia Spradling
+ 17 colours

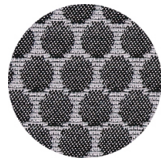

Bubble Flukso
+ 9 colours



Europost 2 Gabriel
+ 16 colours



Fame Gabriel
+ 23 colours



Parotega NF
Skai Hornschuch
+ 8 colours

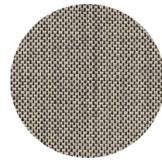

Balta Vescom
+ 12 colours

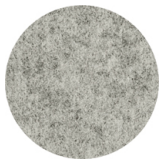

Blazer Camira
+ 14 colours

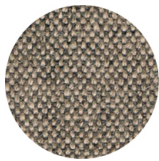

Main line flax Camira
+ 13 colours

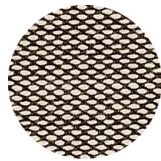

Steelcut trio 3
Kvadrat
+ 20 colours

PP POLYPROPYLENE



RAL 9016 Traffic white
≡



RAL 3000 Flame red
≡



RAL 7016 Anthracite
grey
≡



RAL 2003 Pastel
orange
≡

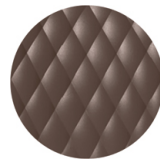

NCS S7005-Y50R
Cocoa
≡



RAL 9005 Jet black
≡



PANTONE 380 C
Boss green
≡



NCS S4005-Y50R Turtle-
dove
≡



PANTONE 18-1438
Marsala
≡

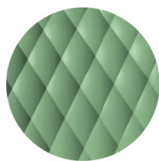

RAL 6021 Pale green
≡

FRAMES

AL PSH POLISHED ALUMINIUM



Polished aluminium

AL VR PAINTED ALUMINIUM

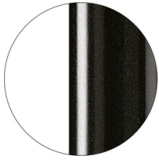

RAL 9005
VR Jet black



Uni-Ka 598

UNI-KA COLLECTION:

Uni-ka 594, Uni-Ka 594M, Uni-Ka 595, Uni-Ka 595M, Uni-Ka 596, Uni-Ka 596M, Uni-Ka 597-DP, Uni-Ka 597-DR, Uni-Ka 597M-DP, Uni-Ka 597M-DR, Uni-Ka 598, Uni-Ka 598M, Uni-Ka 599M, Uni-Ka 599, Uni-Ka 600, Uni-Ka 600M, Uni-Ka 601, Uni-Ka 601M, Uni-Ka 604, Uni-Ka 604M,

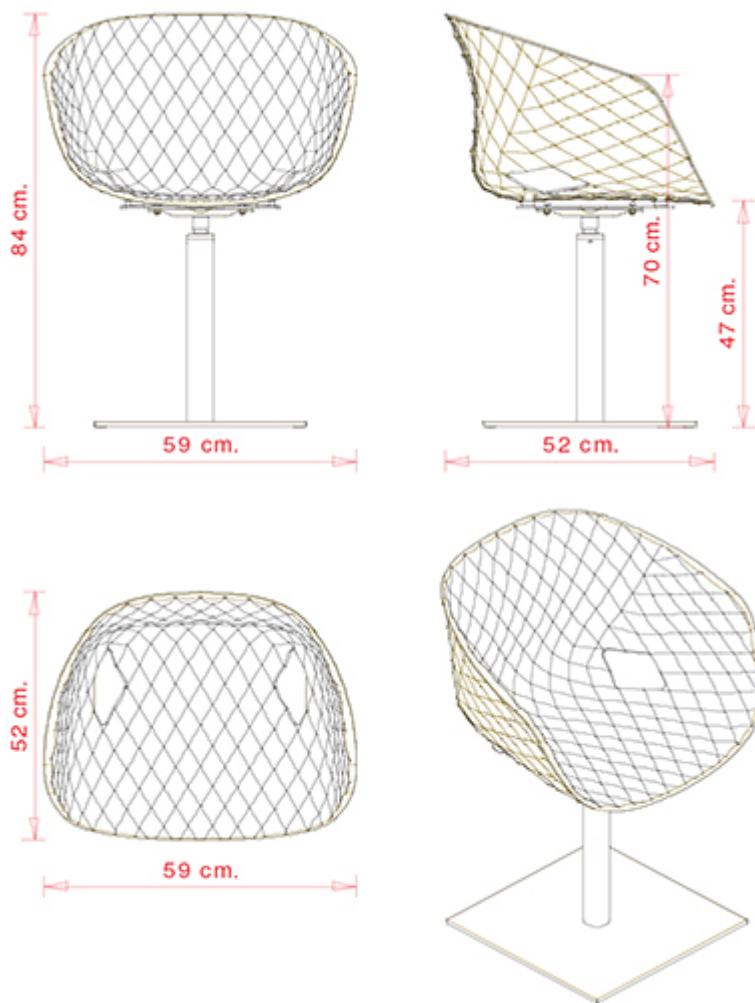

Swivel armchair with central steel base, kick back device and polypropylene shell.

WEIGHT

15,8 kg

PACK

0,34 m³

PIECES PER BOX

1

FINISHES SEATING

PP POLYPROPYLENE



RAL 9016 Traffic white
≡



RAL 3000 Flame red
≡



RAL 7016 Anthracite grey
≡



RAL 2003 Pastel orange
≡

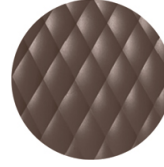

NCS S7005-Y50R
Cocoa
≡



RAL 9005 Jet black
≡



PANTONE 380 C
Boss green
≡



NCS S4005-Y50R
Turtle-dove
≡



PANTONE 18-1438
Marsala
≡

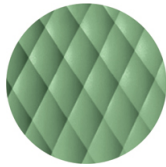

RAL 6021 Pale green
≡

FRAMES

AC STEEL

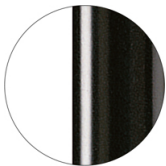

RAL 9005
VR Jet black
☀

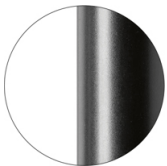

RAL 9005
VR Matt Jet Black
☀



RAL 9016
VR Traffic white
☀



RAL 9010
VR Pure white
☀

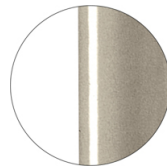

PANTONE 402 C
VR Turtle-dove
☀

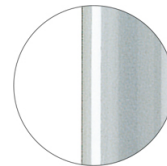

RAL 9006
VR White aluminium
☀

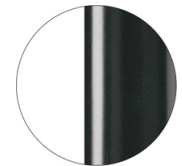

RAL 7016
VR Anthracite grey
☀

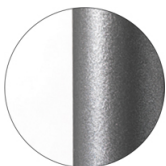

VR Pewter
☀

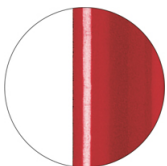

RAL 3003
VR Ruby red
☀

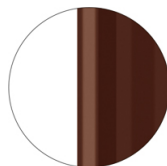

RAL 8017
VR Chocolate brown
☀



RAL 6005
VR Moss green
☀

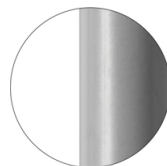

RAL 7037
VR Matt Dusty grey
☀

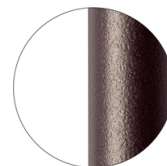

VR Rough metallic
bronze
☀



CR Chrome

Uni-Ka 598M

UNI-KA COLLECTION:

Uni-ka 594, Uni-Ka 594M, Uni-Ka 595, Uni-Ka 595M, Uni-Ka 596, Uni-Ka 596M, Uni-Ka 597-DP, Uni-Ka 597-DR, Uni-Ka 597M-DP, Uni-Ka 597M-DR, Uni-Ka 598, Uni-Ka 598M, Uni-Ka 599M, Uni-Ka 599, Uni-Ka 600, Uni-Ka 600M, Uni-Ka 601, Uni-Ka 601M, Uni-Ka 604, Uni-Ka 604M,

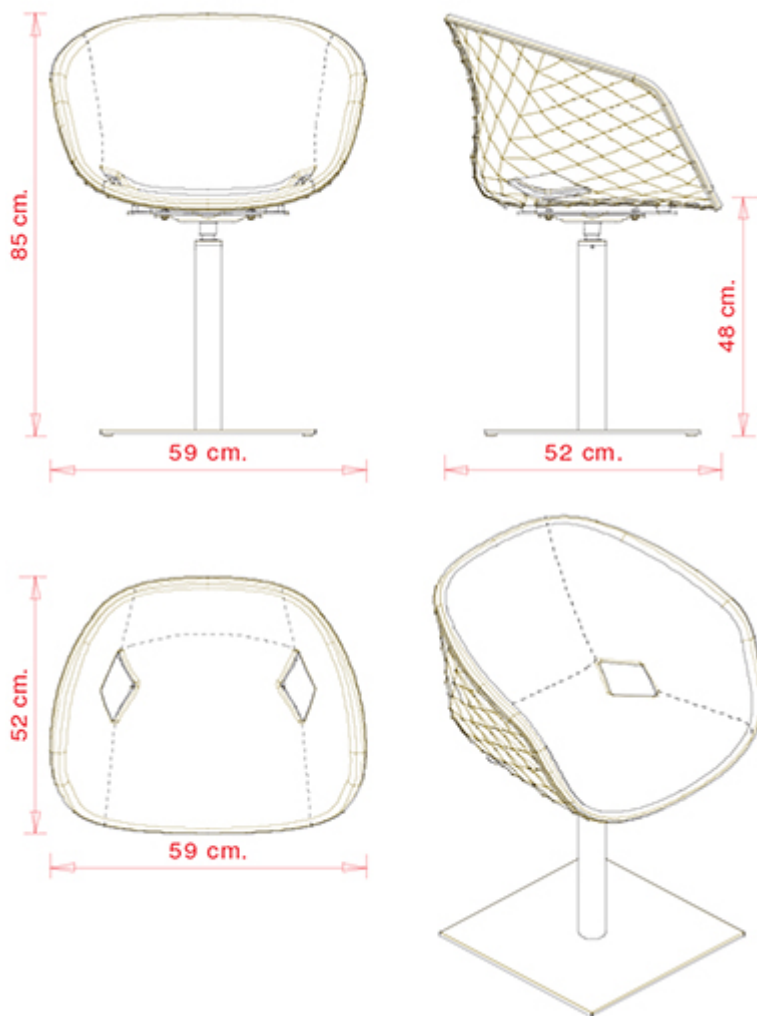

Swivel armchair with central steel base, kick back device and upholstered polypropylene shell.

WEIGHT

18,7 Kg

PACK

0,34 m³

PIECES PER BOX

1

FINISHES SEATING

TE FABRICS



Citadel Camira
+ 16 colours



Inca Abitex
+ 15 colours



Medley Gabriel
+ 14 colours

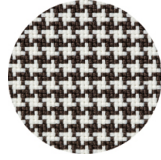

Go-Couture Gabriel
+ 8 colours



Crazy Flukso
+ 7 colours



Xtreme Camira
+ 16 colours

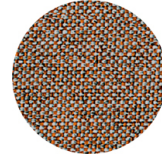

Rivet Camira
+ 12 colours

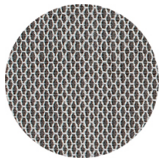

Criss Cross Gabriel
+ 19 colours



Valencia Spradling
+ 17 colours

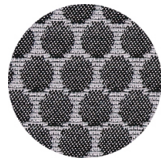

Bubble Flukso
+ 9 colours



Europost 2 Gabriel
+ 16 colours



Fame Gabriel
+ 23 colours



Parotega NF
Skai Hornschuch
+ 8 colours

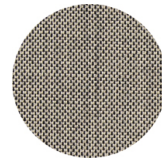

Balta Vescom
+ 12 colours

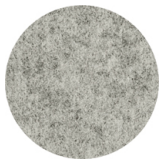

Blazer Camira
+ 14 colours

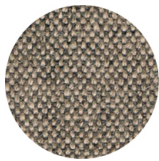

Main line flax Camira
+ 13 colours

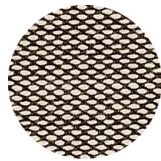

Steelcut trio 3
Kvadrat
+ 20 colours

PP POLYPROPYLENE



RAL 9016 Traffic white
≡



RAL 3000 Flame red
≡



RAL 7016 Anthracite
grey
≡



RAL 2003 Pastel
orange
≡

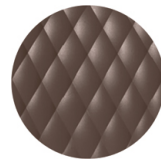

NCS S7005-Y50R
Cocoa
≡



RAL 9005 Jet black
≡



PANTONE 380 C
Boss green
≡



NCS S4005-Y50R Turtle-
dove
≡



PANTONE 18-1438
Marsala
≡

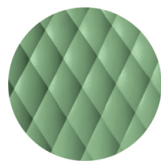

RAL 6021 Pale green
≡

FRAMES

AC STEEL

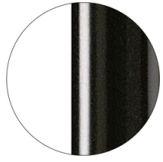

RAL 9005
VR Jet black
☀

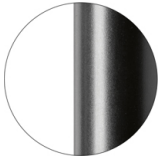

RAL 9005
VR Matt Jet Black
☀



RAL 9016
VR Traffic white
☀



RAL 9010
VR Pure white
☀

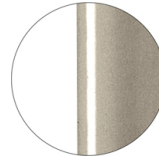

PANTONE 402 C
VR Turtle-dove
☀

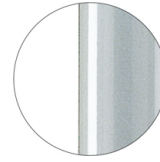

RAL 9006
VR White aluminium
☀

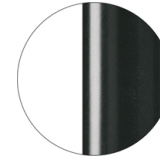

RAL 7016
VR Anthracite grey
☀

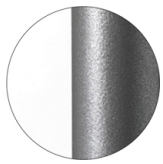

VR Pewter
☀

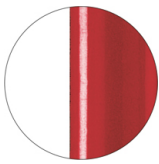

RAL 3003
VR Ruby red
☀

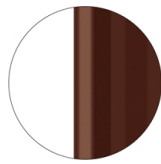

RAL 8017
VR Chocolate brown
☀



RAL 6005
VR Moss green
☀

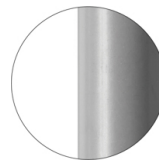

RAL 7037
VR Matt Dusty grey
☀

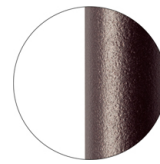

VR Rough metallic
bronze
☀



CR Chrome

Uni-Ka 599M

UNI-KA COLLECTION:

Uni-ka 594, Uni-Ka 594M, Uni-Ka 595, Uni-Ka 595M, Uni-Ka 596, Uni-Ka 596M, Uni-Ka 597-DP, Uni-Ka 597-DR, Uni-Ka 597M-DP, Uni-Ka 597M-DR, Uni-Ka 598, Uni-Ka 598M, Uni-Ka 599M, Uni-Ka 599, Uni-Ka 600, Uni-Ka 600M, Uni-Ka 601, Uni-Ka 601M, Uni-Ka 604, Uni-Ka 604M,

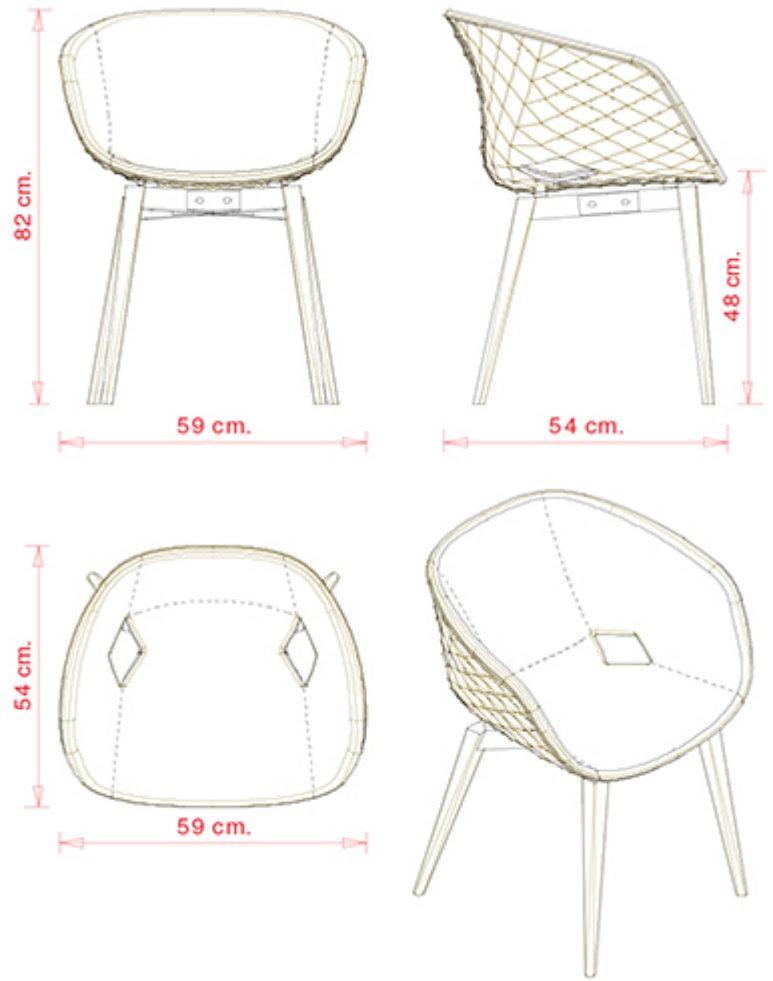

Armchair with beech wood frame, 4 legs. Upholstered polypropylene shell.

WEIGHT

9,4 Kg

PACK

0,34 m³

PIECES PER BOX

1

FINISHES SEATING

TE FABRICS



Citadel Camira
+ 16 colours



Inca Abitex
+ 15 colours



Medley Gabriel
+ 14 colours

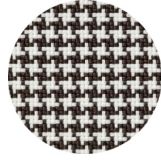

Go-Couture Gabriel
+ 8 colours



Crazy Flukso
+ 7 colours



Xtreme Camira
+ 16 colours

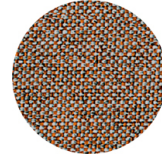

Rivet Camira
+ 12 colours

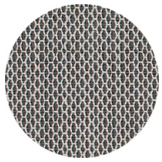

Criss Cross Gabriel
+ 19 colours



Valencia Spradling
+ 17 colours



Bubble Flukso
+ 9 colours



Europost 2 Gabriel
+ 16 colours



Fame Gabriel
+ 23 colours



Parotega NF
Skai Hornschuch
+ 8 colours

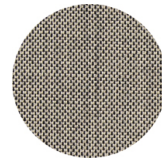

Balta Vescom
+ 12 colours

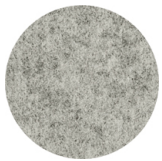

Blazer Camira
+ 14 colours

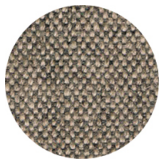

Main line flax Camira
+ 13 colours

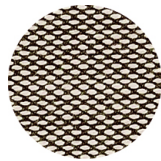

Steelcut trio 3
Kvadrat
+ 20 colours

PP POLYPROPYLENE



RAL 9016 Traffic white
≡



RAL 3000 Flame red
≡



RAL 7016 Anthracite
grey
≡



RAL 2003 Pastel
orange
≡

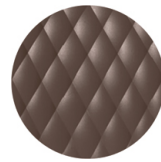

NCS S7005-Y50R
Cocoa
≡



RAL 9005 Jet black
≡



PANTONE 380 C
Boss green
≡



NCS S4005-Y50R Turtle-
dove
≡



PANTONE 18-1438
Marsala
≡

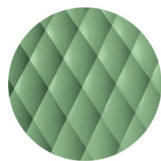

RAL 6021 Pale green
≡

FRAMES

LE WOOD



Maple stained beech wood



Natural beech wood



Wengé stained beech wood



Black stained beech wood



"Canaletto" walnut stained beech wood



Oak stained beech wood

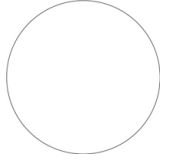

Stained according to sample

Uni-Ka 599

UNI-KA COLLECTION:

Uni-ka 594, Uni-Ka 594M, Uni-Ka 595, Uni-Ka 595M, Uni-Ka 596, Uni-Ka 596M, Uni-Ka 597-DP, Uni-Ka 597-DR, Uni-Ka 597M-DP, Uni-Ka 597M-DR, Uni-Ka 598, Uni-Ka 598M, Uni-Ka 599M, Uni-Ka 599, Uni-Ka 600, Uni-Ka 600M, Uni-Ka 601, Uni-Ka 601M, Uni-Ka 604, Uni-Ka 604M,

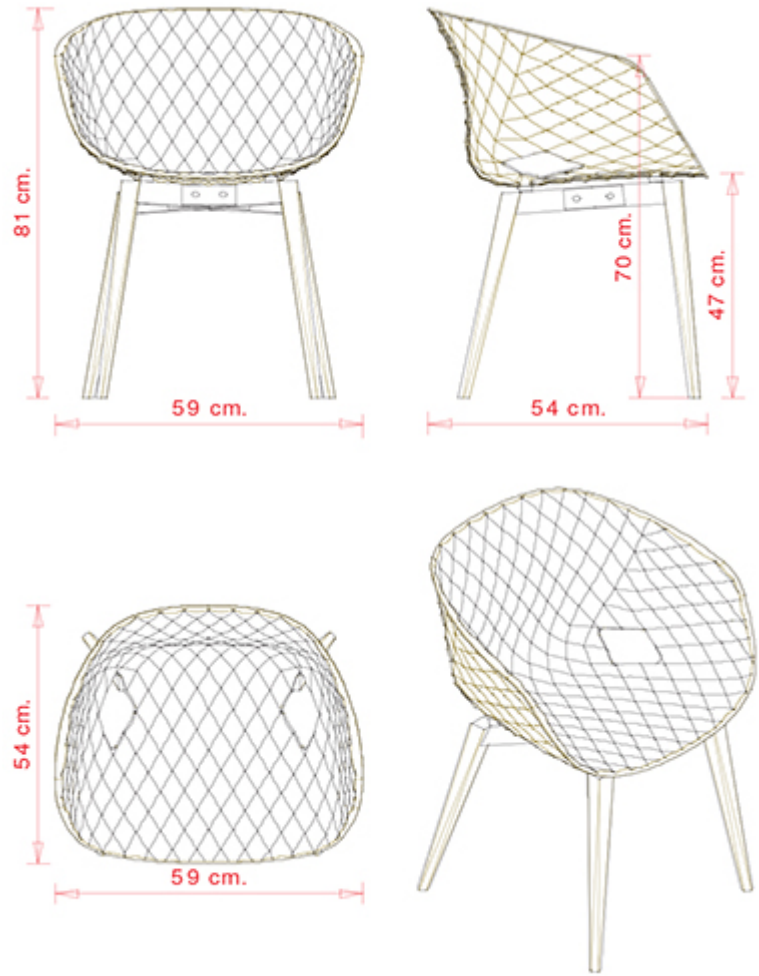

Armchair with beech wood frame, 4 legs. Polypropylene shell.

WEIGHT

6,5 kg

PACK

0,34 m³

PIECES PER BOX

1

FINISHES SEATING

PP POLYPROPYLENE



RAL 9016 Traffic white
≡



RAL 3000 Flame red
≡



RAL 7016 Anthracite
grey
≡



RAL 2003 Pastel
orange
≡



NCS S7005-Y50R
Cocoa
≡



RAL 9005 Jet black
≡



PANTONE 380 C
Boss green
≡



NCS S4005-Y50R
Turtle-dove
≡



PANTONE 18-1438
Marsala
≡

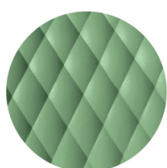

RAL 6021 Pale green
≡

FRAMES

LE WOOD



Maple stained beech
wood



Natural beech wood



Wengé stained beech
wood



Black stained beech
wood



"Canaletto" walnut
stained beech wood



Oak stained beech
wood

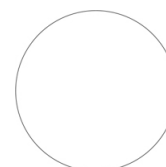

Stained according to
sample

CERTIFICATIONS

- > UNI/EN 16139:2013 - Prova 12. Carico statico gambe anteriori: 2-Uso estremo (03/04/15)
- > UNI/EN 16139:2013 - Prova 13. Carico statico gambe laterali: 2-Uso estremo (03/04/15)
- > UNI/EN 16139:2013 - Prova 8. Prova di fatica sedile e schienale: 2-Uso estremo (03/04/15)
- > UNI/EN 16139:2013 - Prova 9. Prova di fatica sul bordo anteriore: 2-Uso estremo (03/04/15)

Uni-Ka 600

UNI-KA COLLECTION:

Uni-ka 594, Uni-Ka 594M, Uni-Ka 595, Uni-Ka 595M, Uni-Ka 596, Uni-Ka 596M, Uni-Ka 597-DP, Uni-Ka 597-DR, Uni-Ka 597M-DP, Uni-Ka 597M-DR, Uni-Ka 598, Uni-Ka 598M, Uni-Ka 599M, Uni-Ka 599, Uni-Ka 600, Uni-Ka 600M, Uni-Ka 601, Uni-Ka 601M, Uni-Ka 604, Uni-Ka 604M,

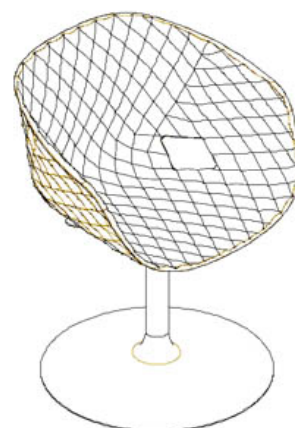
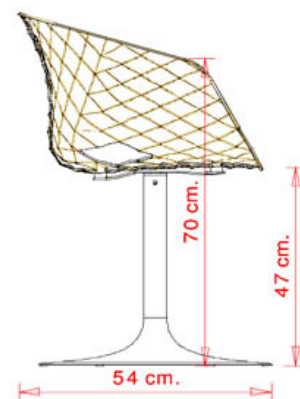
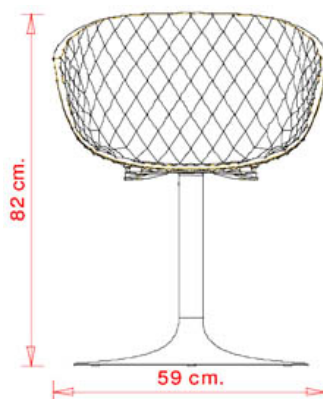

Swivel armchair with central steel base. Polypropylene shell.

WEIGHT

10,6 kg

PACK

0,34 m³

PIECES PER BOX

1

FINISHES SEATING

PP POLYPROPYLENE



RAL 9016 Traffic white
≡



RAL 3000 Flame red
≡



RAL 7016 Anthracite grey
≡



RAL 2003 Pastel orange
≡

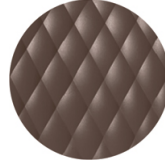

NCS S7005-Y50R
Cocoa
≡



RAL 9005 Jet black
≡



PANTONE 380 C
Boss green
≡



NCS S4005-Y50R
Turtle-dove
≡



PANTONE 18-1438
Marsala
≡

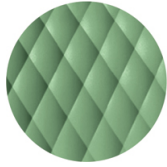

RAL 6021 Pale green
≡

FRAMES

AC STEEL

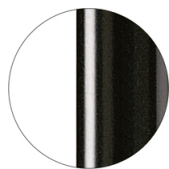

RAL 9005
VR Jet black

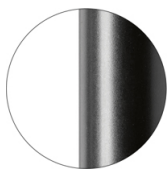

RAL 9005
VR Matt Jet Black



RAL 9016
VR Traffic white



RAL 9010
VR Pure white

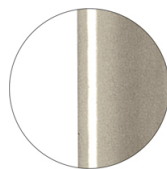

PANTONE 402 C
VR Turtle-dove

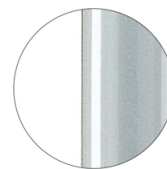

RAL 9006
VR White aluminium

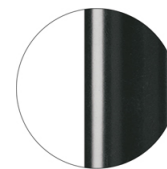

RAL 7016
VR Anthracite grey

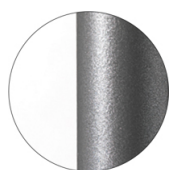

VR Pewter

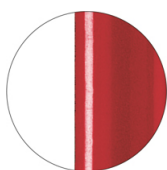

RAL 3003
VR Ruby red

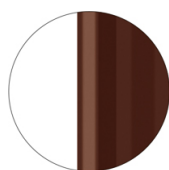

RAL 8017
VR Chocolate brown



RAL 6005
VR Moss green

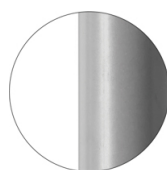

RAL 7037
VR Matt Dusty grey

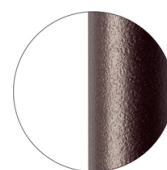

VR Rough metallic bronze

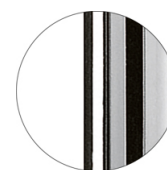

CR Chrome

CERTIFICATIONS

> UNI/EN 16139:2013 - Par.6. Prova 8. Prova di fatica sedile e schienale: 2-Uso estremo (21/09/16)

Uni-Ka 600M

UNI-KA COLLECTION:

Uni-ka 594, Uni-Ka 594M, Uni-Ka 595, Uni-Ka 595M, Uni-Ka 596, Uni-Ka 596M, Uni-Ka 597-DP, Uni-Ka 597-DR, Uni-Ka 597M-DP, Uni-Ka 597M-DR, Uni-Ka 598, Uni-Ka 598M, Uni-Ka 599M, Uni-Ka 599, Uni-Ka 600, Uni-Ka 600M, Uni-Ka 601, Uni-Ka 601M, Uni-Ka 604, Uni-Ka 604M,

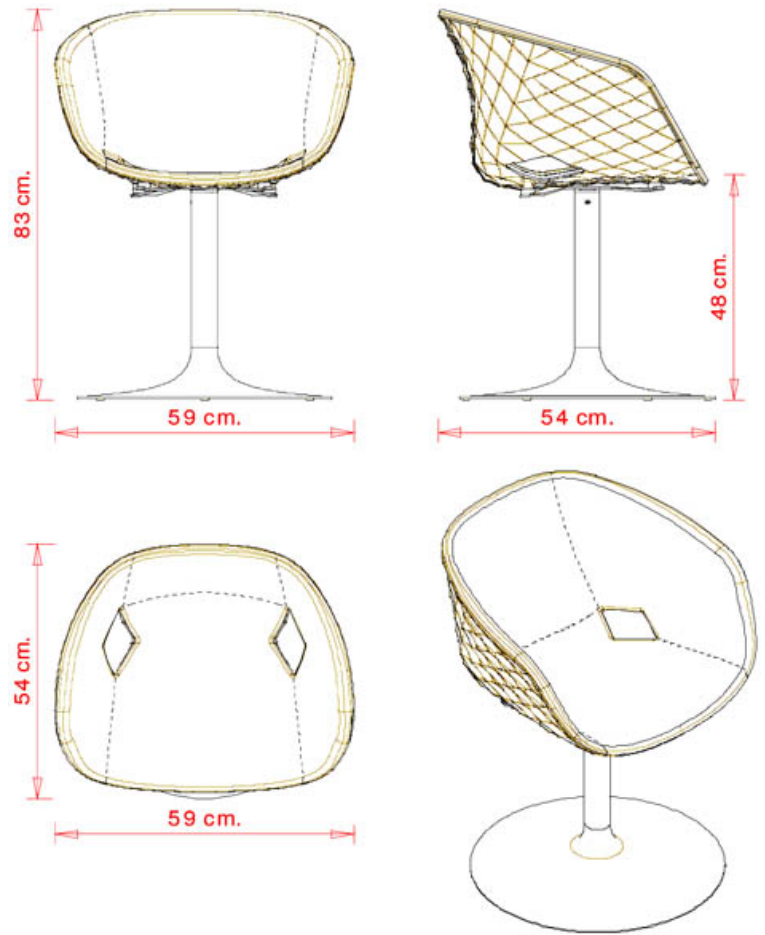

Swivel armchair with central steel base. Upholstered polypropylene shell.

WEIGHT

13,5 Kg

PACK

0,34 m³

PIECES PER BOX

1

FINISHES SEATING

TE FABRICS



Citadel Camira
+ 16 colours



Inca Abitex
+ 15 colours



Medley Gabriel
+ 14 colours

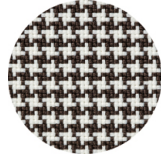

Go-Couture Gabriel
+ 8 colours



Crazy Flukso
+ 7 colours



Xtreme Camira
+ 16 colours

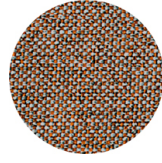

Rivet Camira
+ 12 colours

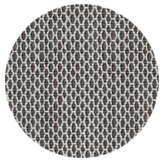

Criss Cross Gabriel
+ 19 colours



Valencia Spradling
+ 17 colours



Bubble Flukso
+ 9 colours



Europost 2 Gabriel
+ 16 colours



Fame Gabriel
+ 23 colours



Parotega NF
Skai Hornschuh
+ 8 colours

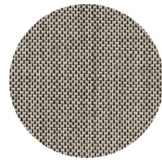

Balta Vescom
+ 12 colours

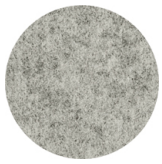

Blazer Camira
+ 14 colours

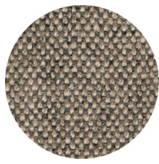

Main line flax Camira
+ 13 colours

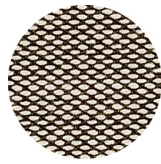

Steelcut trio 3
Kvadrat
+ 20 colours

PP POLYPROPYLENE



RAL 9016 Traffic white
≡



RAL 3000 Flame red
≡



RAL 7016 Anthracite
grey
≡



RAL 2003 Pastel
orange
≡



NCS S7005-Y50R
Cocoa
≡



RAL 9005 Jet black
≡



NCS S4005-Y50R
Turtle-dove
≡



PANTONE 18-1438
Marsala
≡

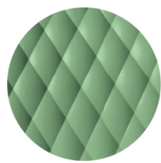

RAL 6021 Pale green
≡

FRAMES

AC STEEL

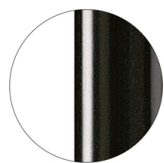

RAL 9005
VR Jet black

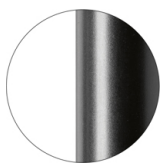

RAL 9005
VR Matt Jet Black



RAL 9016
VR Traffic white



RAL 9010
VR Pure white

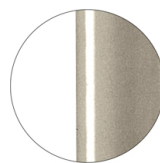

PANTONE 402 C
VR Turtle-dove

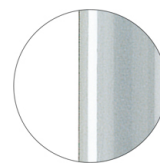

RAL 9006
VR White aluminium

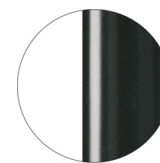

RAL 7016
VR Anthracite grey

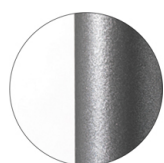

VR Pewter

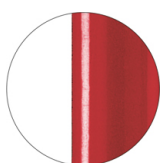

RAL 3003
VR Ruby red

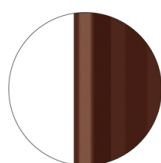

RAL 8017
VR Chocolate brown



RAL 6005
VR Moss green

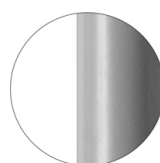

RAL 7037
VR Matt Dusty grey

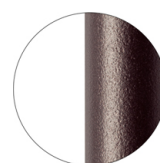

VR Rough metallic
bronze



CR Chrome

CERTIFICATIONS

> UNI/EN 16139:2013 - Par.6. Prova 8. Prova di fatica sedile e schienale: 2-Usò estremo (23/04/2017)

Uni-Ka 601

UNI-KA COLLECTION:

Uni-ka 594, Uni-Ka 594M, Uni-Ka 595, Uni-Ka 595M, Uni-Ka 596, Uni-Ka 596M, Uni-Ka 597-DP, Uni-Ka 597-DR, Uni-Ka 597M-DP, Uni-Ka 597M-DR, Uni-Ka 598, Uni-Ka 598M, Uni-Ka 599M, Uni-Ka 599, Uni-Ka 600, Uni-Ka 600M, Uni-Ka 601, Uni-Ka 601M, Uni-Ka 604, Uni-Ka 604M,

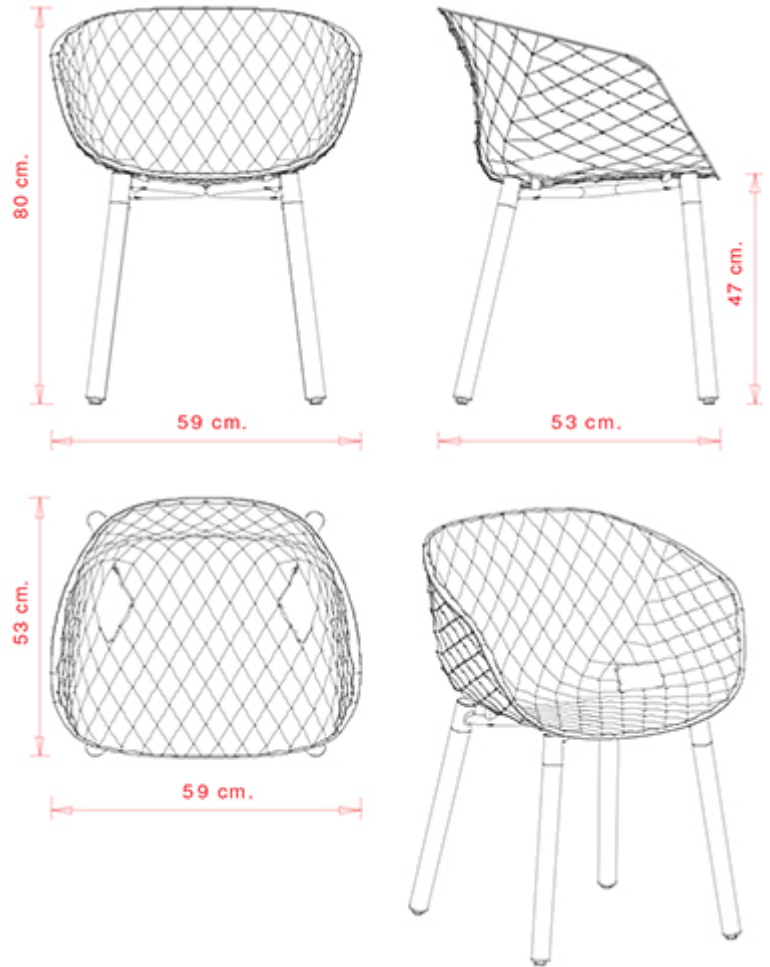

Armchair with beech wood frame, 4 legs. Polypropylene shell.

WEIGHT

6,8 Kg

PACK

0,34 m³

PIECES PER BOX

1

FINISHES SEATING

PP POLYPROPYLENE



RAL 9016 Traffic white
≡



RAL 3000 Flame red
≡



RAL 7016 Anthracite
grey
≡



RAL 2003 Pastel
orange
≡

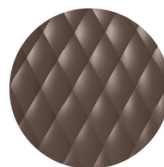

NCS S7005-Y50R
Cocoa
≡



RAL 9005 Jet black
≡



PANTONE 380 C
Boss green
≡



NCS S4005-Y50R
Turtle-dove
≡



PANTONE 18-1438
Marsala
≡

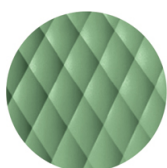

RAL 6021 Pale green
≡

FRAMES

LE WOOD



Maple stained beech
wood



Natural beech wood



Wengé stained beech
wood



Black stained beech
wood



"Canaletto" walnut
stained beech wood



Oak stained beech
wood

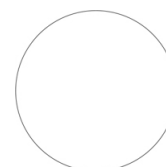

Stained according to
sample

CERTIFICATIONS

- > UNI/EN 16139:2013 - Par.6. Prova 12. Prova di carico statico gambe anteriori: 2-Uso estremo
- > UNI/EN 16139:2013 - Par.4.3. Stabilità. Non si ribalta (16/03/16)
- > UNI/EN 16139:2013 - Par.6. Prova 13. Prova di carico statico gambe laterali: 2-Uso estremo (16/03/16)
- > UNI/EN 16139:2013 - Par.6. Prova 8. Prova di fatica sedile e schienale: 2-Uso estremo (16/03/16)

Uni-Ka 601M

UNI-KA COLLECTION:

Uni-ka 594, Uni-Ka 594M, Uni-Ka 595, Uni-Ka 595M, Uni-Ka 596, Uni-Ka 596M, Uni-Ka 597-DP, Uni-Ka 597-DR, Uni-Ka 597M-DP, Uni-Ka 597M-DR, Uni-Ka 598, Uni-Ka 598M, Uni-Ka 599M, Uni-Ka 599, Uni-Ka 600, Uni-Ka 600M, Uni-Ka 601, Uni-Ka 601M, Uni-Ka 604, Uni-Ka 604M,

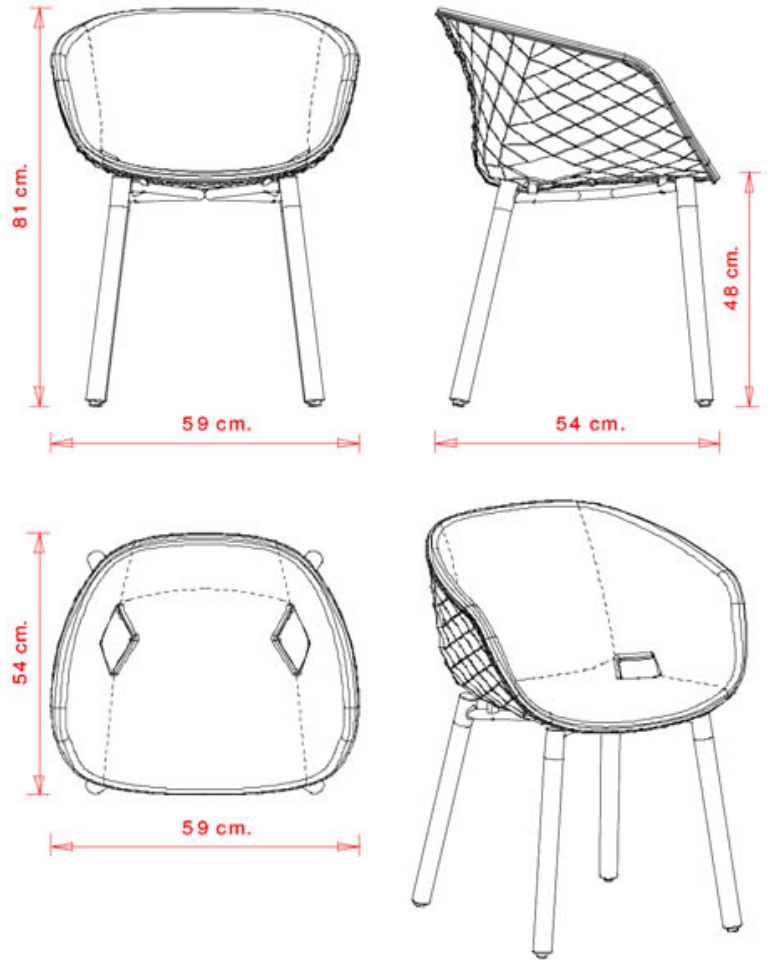

Armchair with beech wood frame, 4 legs. Upholstered polypropylene shell.

WEIGHT

9,7 kg

PACK

0,34 m³

PIECES PER BOX

1

FINISHES SEATING

TE FABRICS



Citadel Camira
+ 16 colours



Inca Abitex
+ 15 colours



Medley Gabriel
+ 14 colours

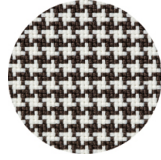

Go-Couture Gabriel
+ 8 colours



Crazy Flukso
+ 7 colours



Xtreme Camira
+ 16 colours

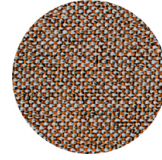

Rivet Camira
+ 12 colours

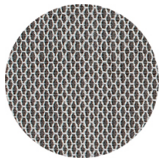

Criss Cross Gabriel
+ 19 colours



Valencia Spradling
+ 17 colours

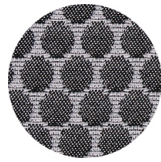

Bubble Flukso
+ 9 colours



Europost 2 Gabriel
+ 16 colours



Fame Gabriel
+ 23 colours



Parotega NF
Skai Hornschuch
+ 8 colours

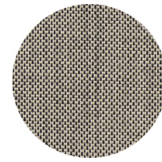

Balta Vescom
+ 12 colours

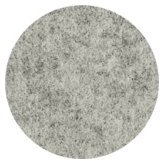

Blazer Camira
+ 14 colours

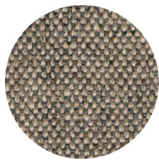

Main line flax Camira
+ 13 colours

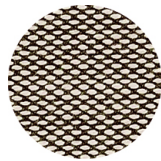

Steelcut trio 3
Kvadrat
+ 20 colours

PP POLYPROPYLENE



RAL 9016 Traffic white
≡



RAL 3000 Flame red
≡



RAL 7016 Anthracite
grey
≡



RAL 2003 Pastel
orange
≡



NCS S7005-Y50R
Cocoa
≡



RAL 9005 Jet black
≡



PANTONE 380 C
Boss green
≡



NCS S4005-Y50R Turtle-
dove
≡



PANTONE 18-1438
Marsala
≡

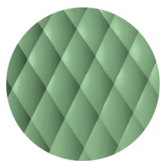

RAL 6021 Pale green
≡

FRAMES

LE WOOD



Maple stained beech wood



Natural beech wood



Wengé stained beech wood



Black stained beech wood



"Canaletto" walnut stained beech wood



Oak stained beech wood

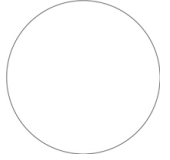

Stained according to sample

Uni-Ka 604



UNI-KA COLLECTION:

Uni-ka 594, Uni-Ka 594M, Uni-Ka 595, Uni-Ka 595M, Uni-Ka 596, Uni-Ka 596M, Uni-Ka 597-DP, Uni-Ka 597-DR, Uni-Ka 597M-DP, Uni-Ka 597M-DR, Uni-Ka 598, Uni-Ka 598M, Uni-Ka 599M, Uni-Ka 599, Uni-Ka 600, Uni-Ka 600M, Uni-Ka 601, Uni-Ka 601M, Uni-Ka 604, Uni-Ka 604M,



Lounge armchair with steel frame, 4 legs. Polypropylene shell.

WEIGHT

6,35 Kg

PACK0,31 m³**PIECES PER BOX**

1

FINISHES SEATING

PP POLYPROPYLENE



RAL 9016 Traffic white
≡



RAL 3000 Flame red
≡



RAL 7016 Anthracite grey
≡



RAL 2003 Pastel orange
≡

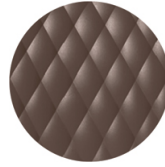

NCS S7005-Y50R
Cocoa
≡



RAL 9005 Jet black
≡



PANTONE 380 C
Boss green
≡



NCS S4005-Y50R
Turtle-dove
≡



PANTONE 18-1438
Marsala
≡

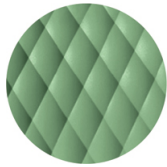

RAL 6021 Pale green
≡

FRAMES

AC STEEL

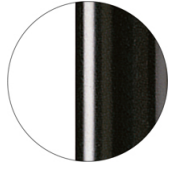

RAL 9005
VR Jet black

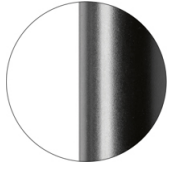

RAL 9005
VR Matt Jet Black



RAL 9016
VR Traffic white



RAL 9010
VR Pure white

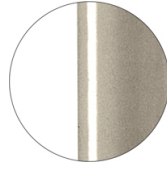

PANTONE 402 C
VR Turtle-dove

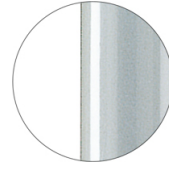

RAL 9006
VR White aluminium

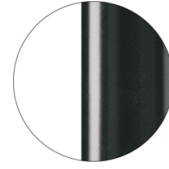

RAL 7016
VR Anthracite grey

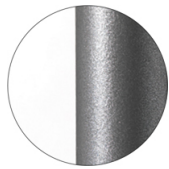

VR Pewter

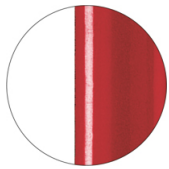

RAL 3003
VR Ruby red

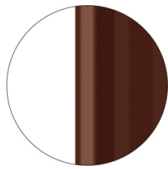

RAL 8017
VR Chocolate brown



RAL 6005
VR Moss green

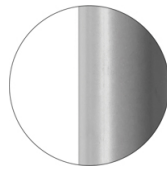

RAL 7037
VR Matt Dusty grey

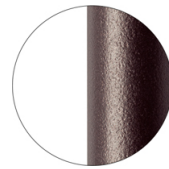

VR Rough metallic bronze



CR Chrome

CERTIFICATIONS

- > UNI/EN 16139:2013 - Par.4 Sicurezza. 4.3 Stabilità (07/07/17)
- > UNI/EN 16139:2013 - Par.6 Prova 13. Prova di carico statico delle gambe laterali: 2-Uso estremo (27/07/17)
- > UNI/EN 16139:2013 - Par.6. Prova 12. Prova di carico statico delle gambe anteriori: 2-Uso estremo (27/07/17)
- > UNI/EN 16139:2013 - Par.6. Prova 8. Prova di fatica sedile e schienale: 2-Uso estremo (21/07/17)

Uni-Ka 604M



UNI-KA COLLECTION:

Uni-ka 594, Uni-Ka 594M, Uni-Ka 595, Uni-Ka 595M, Uni-Ka 596, Uni-Ka 596M, Uni-Ka 597-DP, Uni-Ka 597-DR, Uni-Ka 597M-DP, Uni-Ka 597M-DR, Uni-Ka 598, Uni-Ka 598M, Uni-Ka 599M, Uni-Ka 599, Uni-Ka 600, Uni-Ka 600M, Uni-Ka 601, Uni-Ka 601M, Uni-Ka 604, Uni-Ka 604M,



Lounge armchair with steel frame, 4 legs. Upholstered polypropylene shell.

WEIGHT

9,25 Kg

PACK0,31 m³**PIECES PER BOX**

1

FINISHES SEATING

TE FABRICS



Citadel Camira
+ 16 colours



Inca Abitex
+ 15 colours



Medley Gabriel
+ 14 colours

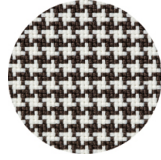

Go-Couture Gabriel
+ 8 colours



Crazy Flukso
+ 7 colours



Xtreme Camira
+ 16 colours

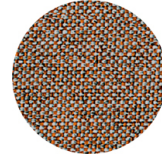

Rivet Camira
+ 12 colours

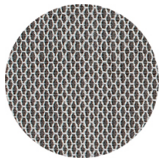

Criss Cross Gabriel
+ 19 colours



Valencia Spradling
+ 17 colours

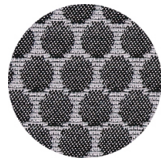

Bubble Flukso
+ 9 colours



Europost 2 Gabriel
+ 16 colours



Fame Gabriel
+ 23 colours



Parotega NF
Skai Hornschuch
+ 8 colours

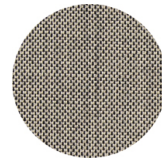

Balta Vescom
+ 12 colours

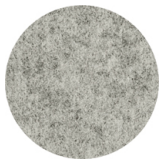

Blazer Camira
+ 14 colours

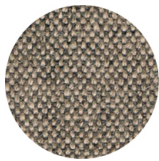

Main line flax Camira
+ 13 colours

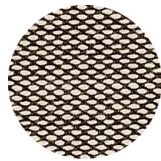

Steelcut trio 3
Kvadrat
+ 20 colours

PP POLYPROPYLENE



RAL 9016 Traffic white
≡



RAL 3000 Flame red
≡



RAL 7016 Anthracite
grey
≡



RAL 2003 Pastel
orange
≡

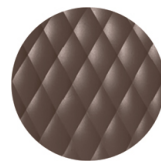

NCS S7005-Y50R
Cocoa
≡



RAL 9005 Jet black
≡



PANTONE 380 C
Boss green
≡



NCS S4005-Y50R Turtle-
dove
≡



PANTONE 18-1438
Marsala
≡

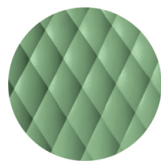

RAL 6021 Pale green
≡

FRAMES

AC STEEL

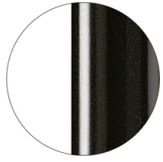

RAL 9005
VR Jet black
☀

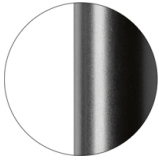

RAL 9005
VR Matt Jet Black
☀



RAL 9016
VR Traffic white
☀



RAL 9010
VR Pure white
☀

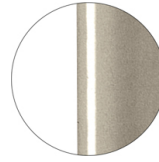

PANTONE 402 C
VR Turtle-dove
☀

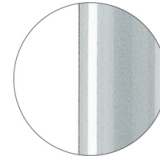

RAL 9006
VR White aluminium
☀

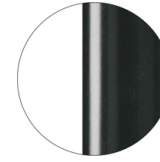

RAL 7016
VR Anthracite grey
☀

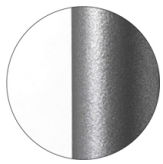

VR Pewter
☀

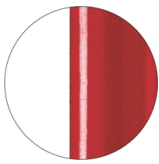

RAL 3003
VR Ruby red
☀

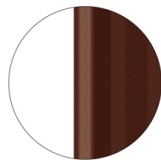

RAL 8017
VR Chocolate brown
☀



RAL 6005
VR Moss green
☀

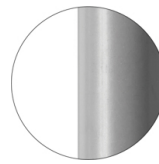

RAL 7037
VR Matt Dusty grey
☀

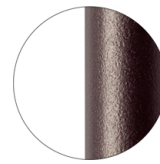

VR Rough metallic
bronze
☀



CR Chrome